

About Samsung Medison CO., LTD.

Samsung Medison, an affiliate of Samsung Electronics, is a global medical company founded in 1985. With a mission to bring health and well-being to people's lives, the company manufactures diagnostic ultrasound systems around the world across various medical fields. Samsung Medison has commercialized the Live 3D technology in 2001 and since being part of Samsung Electronics in 2011, it is integrating IT, image processing, semiconductor and communication technologies into ultrasound devices for efficient and confident diagnosis.

- * This product, features, options and transducers are not commercially available in all countries.
- * Due to regulatory reasons their future availability cannot be guaranteed. Please contact your local sales network for further details.
- * This product is a medical device, please read the user manual carefully before use.
- * S-Vue Transducer™ is the name of Samsung's advanced transducer technology.
- * Lumiflow™ feature will be available in certain countries within March 2019.



Scan code or visit
www.samsunghealthcare.com
to learn more

SAMSUNG MEDISON CO., LTD.

© 2018 Samsung Medison All Rights Reserved.
Samsung Medison reserves the right to modify the design, packaging, specifications, and features shown herein, without prior notice or obligation.



CT-HERA W10 V1.0 a-EDA-181128-EN

samsunghealthcare.com

New Momentum of Imaging

HERA W10

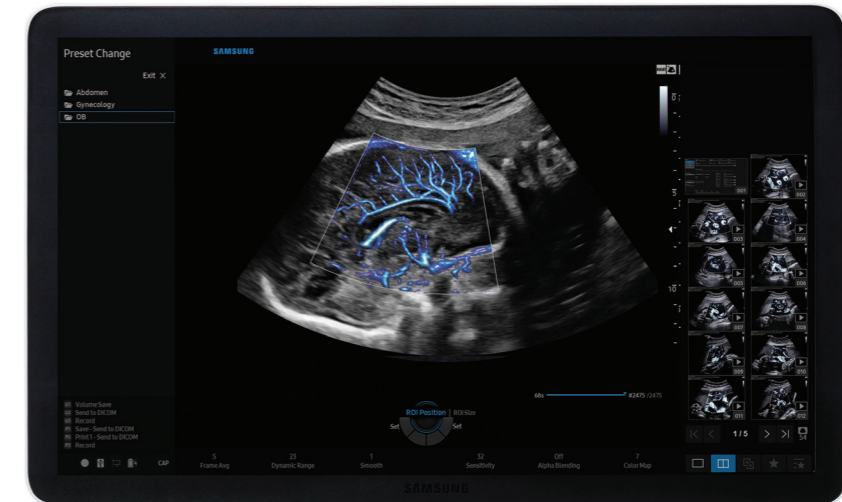

SAMSUNG

NEW MOMENTUM OF IMAGING

HERA, an acronym stands for Hyper-aperture and Enhanced Reconstruction Architecture, is Samsung's new preeminent ultrasound platform committed to deliver astonishing images. Likewise, HERA platform offers access to the state-of-the-art ergonomics with simple yet ingenious look for the satisfaction in medical care.

HERA W10, the premier model of the HERA platform, will help you get more insight in diagnosis with its intuitive visualizations, precise analytic features, and instant operation. It is our commitment for Obstetrics and Gynecology applications to support for life-long healthcare of women, diligently pursuing for new possibilities in ultrasound diagnosis.

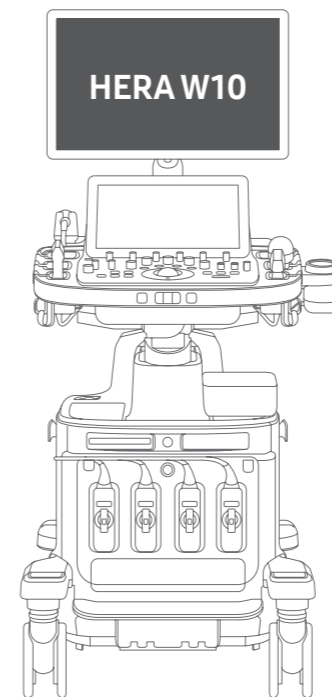

REDEFINED IMAGING TECHNOLOGIES POWERED BY Crystal Architecture™

Crystal Architecture™, an imaging architecture that combines CrystalBeam™ and CrystalLive™, based on S-Vue Transducer™, is to provide crystal clear image. CrystalBeam™ is a new beamforming technology beneficial in delivering high-quality image resolution and increased uniformity of images.

CrystalLive™ is Samsung's up-to-date ultrasound imaging engine with enhanced 2D image processing, 3D rendering and color signal processing, to offer outstanding image performance and efficient workflow during complex cases.



X10 Data Transfer Rate *
for fast frame rates



X11 Processing Power *
for high-quality images



X3 GPU Memory *
for fast rendering

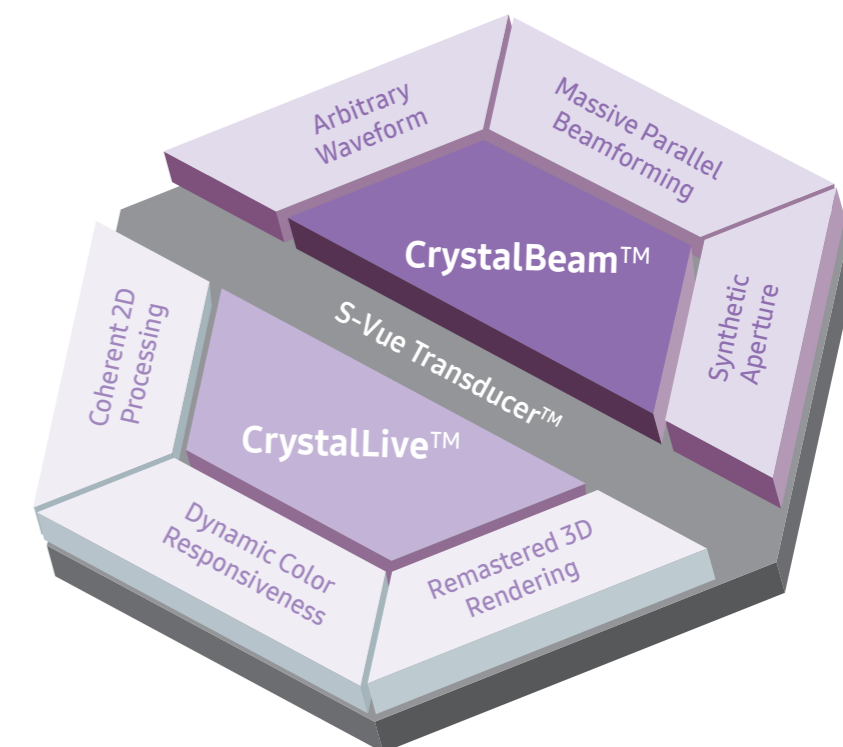

Crystal Architecture™

* Compared to the Samsung WS80A

A NEW BEAMFORMING FOR IN-DEPTH IMAGE CREATION

CrystalBeam™ utilizes Arbitrary Waveform Transmission, Massive Parallel Beamforming, and Synthetic Aperture technologies to produce a faster frame rate and improved image uniformity. Arbitrary Waveform Transmit refers to a widely-focused beam transmission technology that allows for more coherent images; sequentially Massive Parallel Beamforming and Synthetic Aperture enable more enriched and faster beam processing, based on a large amount of acquired ultrasound data.

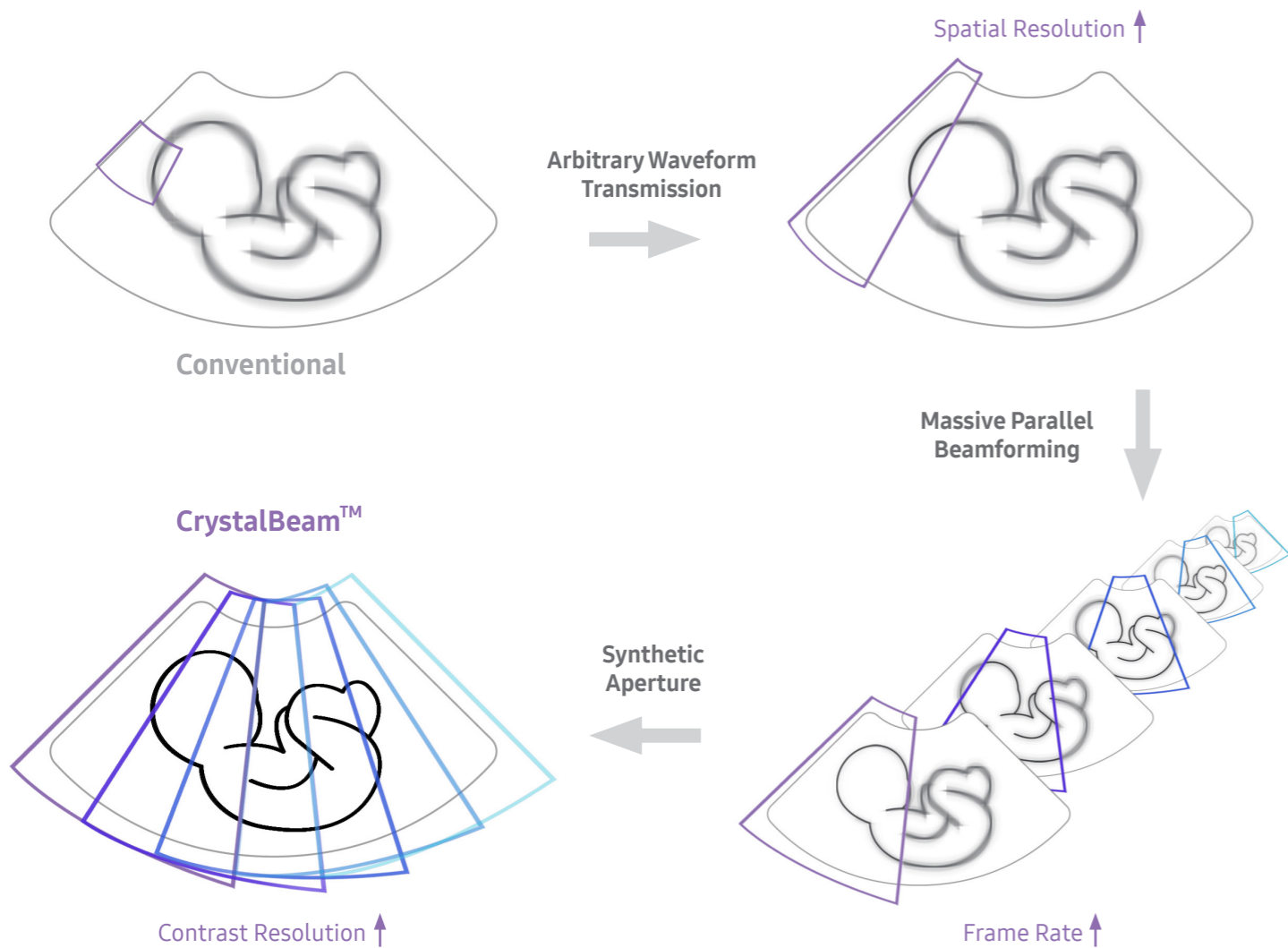

* Compared to the Samsung WS80A

SOPHISTICATED 2D IMAGES PROCESSED BY CrystalLive™

CrystalLive™ helps you to make more confident diagnoses with fundamental 2D images. Some major advantages of 2D images include shadow-suppressed images, lessened halo artifacts, and mitigated blurred area. ShadowHDR™ is a key feature that shows shadowy areas, making it especially applicable for use in highly attenuated regions, such as fetal head or spine.

ShadowHDR™



ShadowHDR™ selectively applies high-frequency and low-frequency of the ultrasound to identify shadowy areas such as fetal head or spine where attenuation occurs.



Fetal brain

ClearVision



ClearVision provides clearer tissue boundaries using the noise reduction filter and generates sharp 2D images. It reduces halo artifact that occurs when the tissue contour is enhanced, and removes noises on the tissue boundaries.

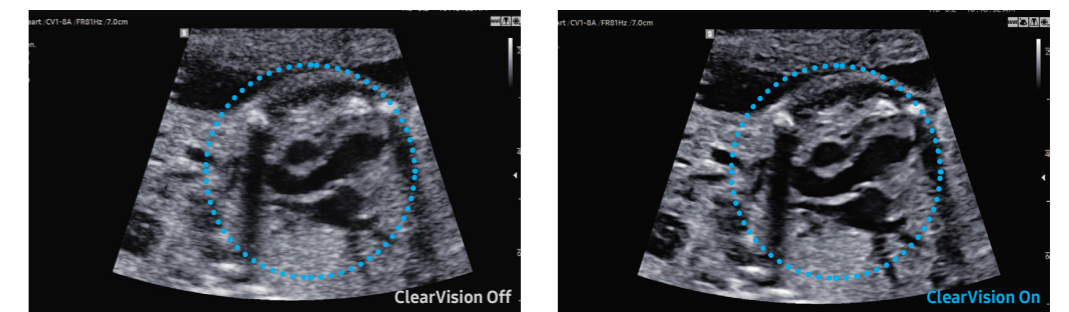

Fetal heart

HQ-Vision™



HQ-Vision™ provides clearer images by mitigating the characteristics of ultrasound images that are slightly blurred than the actual vision.

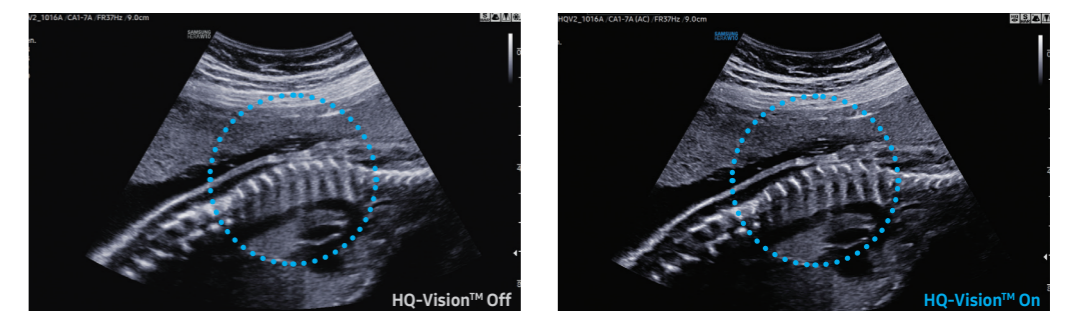

Fetal spine

REALISTIC DESCRIPTION OF 3D/4D PERFORMANCE

CrystalLive™ in 3D/4D provides users with more realistic and high-resolution images. It outdoes conventional 3D imaging technologies in terms of viewing small parts and lighting effects. In addition, you are able to see 3D anatomy with more realistic depth perception, and can visualize the internal and external structures at once.

HDVI™ 2.0



HDVI™ is a volume rendering technology that improves visualization of edges and small structures in volume data. Upgraded marginal expression and image saturation expresses the very details from angle to shadow of the fetus.



Fetal face with 3D



Fetal spine with 3D

RealisticVue™



RealisticVue™ displays high resolution 3D anatomy with exceptional detail and realistic depth perception. User selectable light source direction creates intricately graduated shadows for better defined anatomical structures.



Fetal face with RealisticVue™

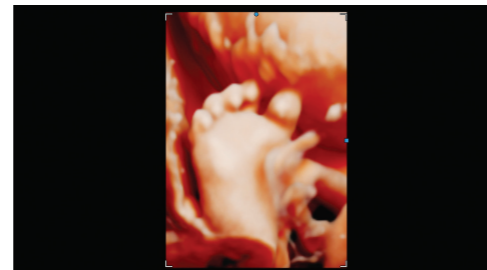

Fetal foot with RealisticVue™

CrystalVue™

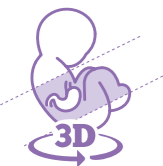

CrystalVue™ is an advanced volume rendering technology that enhances visualization of both internal and external structures in a single rendered image using a combination of intensity, gradient and position.

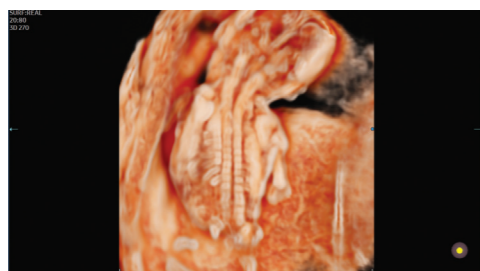

Fetal spine with CrystalVue™



Fetal profile with CrystalVue™

DETAILED EXPRESSION OF BLOOD FLOW DYNAMICS

Color performance of CrystalLive™ has been improved to clearly visualize the hemodynamics of the blood flow. Greater sensitivity resulting from new color signal processing allows for a more accurate detection of peripheral blood vessels, microcirculatory blood flows, and volumes of slow blood flows.

S-Flow™

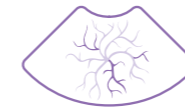

S-Flow™, a directional Power Doppler imaging technology, can help to detect even the peripheral blood vessels. It enables accurate diagnosis when the blood flow examination is especially difficult.

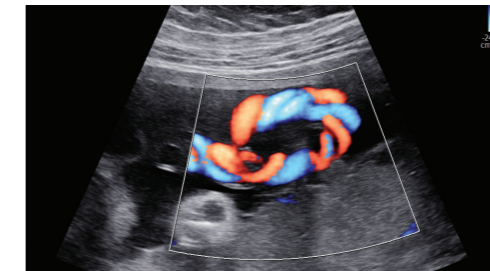

Umbilical cord with S-Flow™

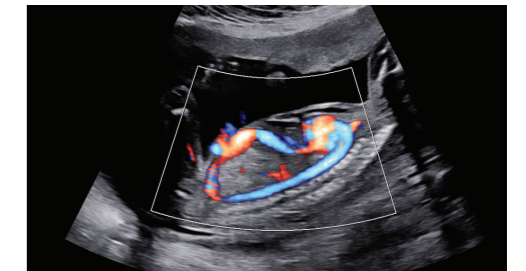

Fetal circulation with S-Flow™

MV-Flow™

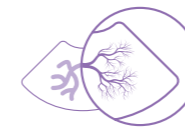

MV-Flow™ offers a novel alternative to power Doppler for visualizing slow flow of microvascularized structures. High frame rates and advanced filtering enable MV-Flow™ to provide a detailed view of blood flow in relation to surrounding tissue or pathology with enhanced spatial resolution.



Placenta with MV-Flow™

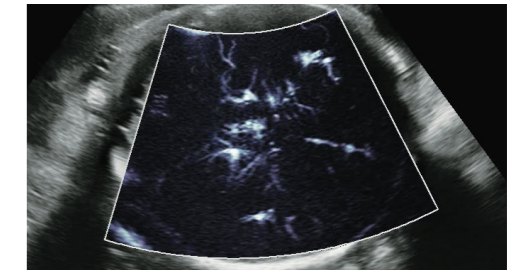

BPD with MV-Flow™

LumiFlow™



LumiFlow™ is a three-dimensional visualization of blood flow, which helps to understand the structure of blood flow and small vessels intuitively.



S-Flow™ with LumiFlow™ (Color cord)



MV-Flow™ with LumiFlow™ (Fetal brain)

STATE-OF-THE-ART ERGODYNAMICS FOR YOUR COMFORT AND PRODUCTIVITY

FreeForm™ refers to Samsung's new design theme. It was developed to provide a more comfortable diagnostic experience by reducing the need for movement from one spot to another. Our goal is to satisfy user's working environment by applying a mechanism to the control panel in its wide-moving range, as well as by considering a user's arm reach. This enables it to offer a sufficient amount of space for the user's knee.

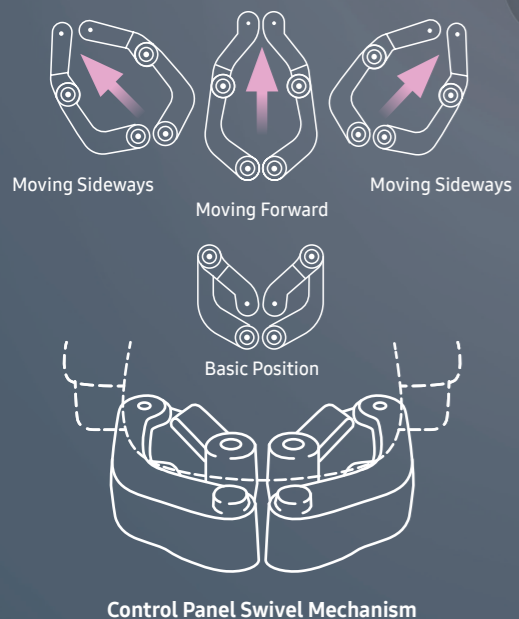
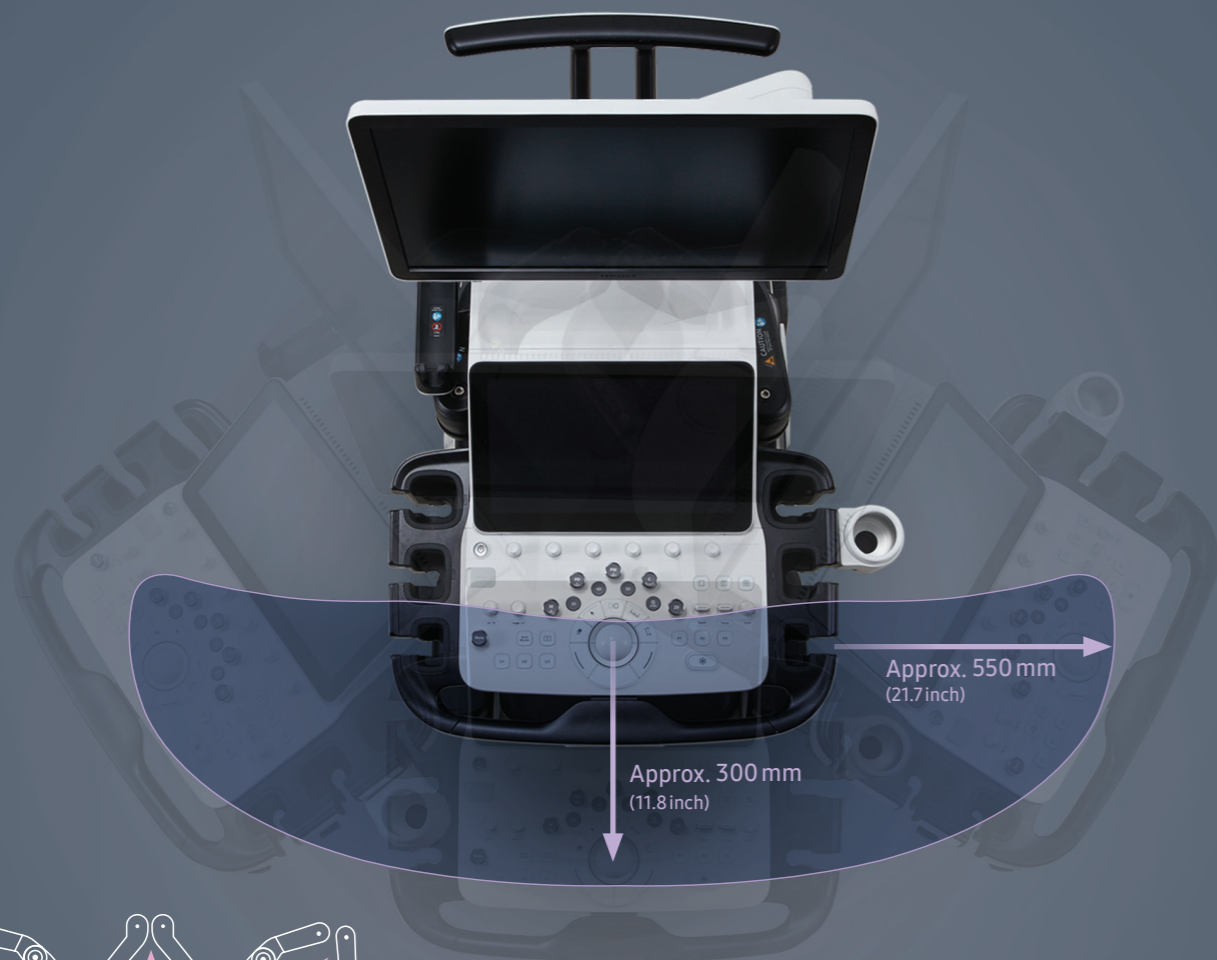

Control Panel Moving Mechanism

An internal study showed that Samsung's Control Panel Moving Mechanism reduces shoulder stress by about a third compared to the previous model. It does this by providing users with more space near the control panel area, resulting in less repetitive strain from hours of scanning. Users can now pull the control panel and rotate its angle at the same time.

* Control panel usability study compared to the Samsung WS80A. Tested using same body postures.



Winner of an IDEA SILVER AWARD 2018

The unique design of the HERA W10 communicates trust and confidence to both the user and the patient. The striking contrast of dark and bright, conventional and ergonomic improvements provides an iconic look for a preminent ultrasound system.



Endocavity Transducer Holder



Cable Management

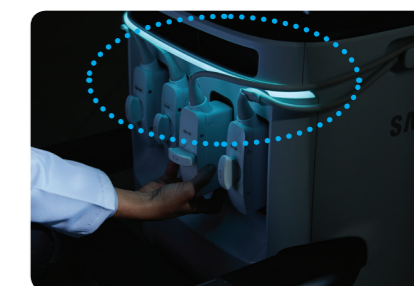

Mood Light

CUSTOMIZABLE FOR THE WAY YOU WORK

We believe that a truly great system offers customer-centric working conditions. Users of the HERA W10 have the option of customizing its diagnostic settings based on personalized protocol. It results in a more streamlined examination process and faster workflows.



QuickPreset for easy transducer preset

With one touch, the user can select the most common transducer and preset combinations. QuickPreset increases efficiency to make a full day of scanning simple and easy.



Touch Customization for your preferences

A customizable touchscreen interface that allows the user to move frequently used functions to the first page, keeping the focus on the patient instead of the system.

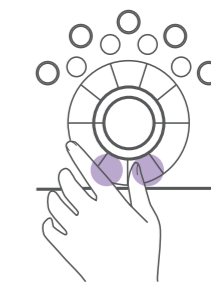

Contextual Button for your convenient access

Depending on the user's choice of ultrasonic inspection items, the required diagnostic functions may be assigned to the control panel buttons to reduce the hassle of menu selection.



FAST BOOT UP WITH MobileSleep

Booting-up from sleep mode saves about 63% of your time, when compared to a normal boot-up. MobileSleep enters to the sleep mode quickly for easy maneuverability of the system.



COMPREHENSIVE SELECTION OF TRANSDUCERS

Volume Transducers



CV1-8A
Abdomen, obstetrics,
gynecology



EV3-10B
Obstetrics, gynecology,
urology

Convex Array Transducers



CA3-10A
Abdomen, obstetrics,
gynecology



CA2-9A
Abdomen, obstetrics,
gynecology



CA1-7A
Abdomen, obstetrics,
gynecology, contrast



CF4-9
Pediatric, vascular

Linear Array Transducers



L3-12A
Small parts, vascular,
musculoskeletal



LA2-9A
Small parts, vascular,
musculoskeletal

Endocavity Transducers



EA2-11B
Obstetrics, gynecology,
urology



VR5-9
Obstetrics, gynecology,
urology



E3-12A
Obstetrics, gynecology,
urology

Phased Array Transducers



PA4-12B
Cardiac, pediatric



PM1-6A
Cardiac, TCD, abdomen



PA3-8B
Cardiac, pediatric, abdomen

Secure your care

Samsung Healthcare Cybersecurity

Bringing peace of mind to your hospital and patients

To address this emerging need for cybersecurity, Samsung provides a solution to support our customers by offering the tools to protect against cyberthreats that may compromise invaluable patient data and ultimately degrade the quality of care. Samsung's Cybersecurity Solution strives to abide by the CIA triad (Confidentiality, Integrity, and Availability) and takes a comprehensive approach to providing impeccable protection with the following pillars: Intrusion prevention, Access control, and Data protection



Intrusion prevention

Tools for protecting against cyber threats from external attacks

- Security tools (Anti-virus & Firewall)
- Secured operating system



Access control

Strengthened surveillance for tracking the access of patient information

- Account management
- Enhanced audit trail



Data protection

Encryption functions for safeguarding data whether at-rest or in-transit

- Data encryption
- Transmission security